

Capacitive Sensors (Type M12, M18)

Type	M12		M12		M12
Type of installation	Flush	Flush	Non-flush	Non-flush	Non-flush
Nominal sensing distance	2 mm	2 mm	4 mm	4 mm	6 mm
Type of connection	Cable 2 m	Connector M8	Cable 2 m	Connector M8	Cable 2 m
Special feature					Sensing dist.

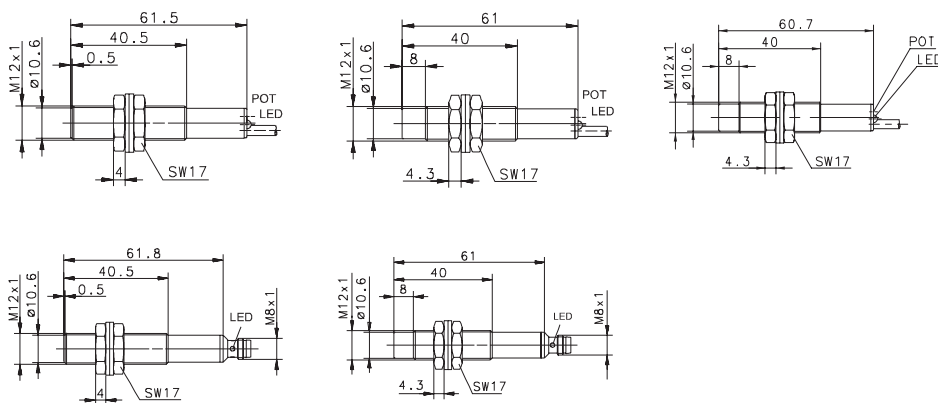

PNP	DC	NO contact Type NC contact Type Antivalent NO/NC Type	6507903001 KCB-M12PS/002-KLP2	6507903004 KCB-M12PS/002-KLSM8	6507919001 KCN-T12PS/004-KLP2	6507919004 KCN-T12PS/004-KLSM8	6607919110 KCN-T12PS/006-KLP2E
NPN	DC	NO contact Type NC contact Antivalent NO/NC	6507303001 KCB-M12NS/002-KLP2		6507319001 KCN-T12NS/004-KLP2		
PNP/NPN	DC	NO/NC prog. push-pull operation					
NAMUR	DC						
Analogue	DC						
2-wire	DC	NO contact NC contact					
	AC	NO contact Type NC contact Type Changeover contact					

Technical data

Rated operating voltage	U_B	10–36 VDC	10–36 VDC	10–36 VDC	10–36 VDC	10–36 VDC
Rated operating current	I_B	200 mA	200 mA	200 mA	200 mA	200 mA
Switching frequency (max)	F	25 Hz	25 Hz	25 Hz	25 Hz	25 Hz
Short circuit-protection		Cyclic	Cyclic	Cyclic	Cyclic	Cyclic
Function/operating voltage indicator		LED/–	LED/–	LED/–	LED/–	LED/–
Sensing distance, adjustable		Poti	–	Poti	–	Poti

Mechanical data

Ambient temperature (min/max)		–25°C/+70°C	–25°C/+70°C	–25°C/+70°C	–25°C/+70°C	–25°C/+70°C
Protection class in accordance with IEC 529, EN 60529		IP65	IP65	IP65	IP65	IP65
Enclosure material		CuZn39Pb3	CuZn39Pb3	PBT, black	PBT, black	PBT, black
Connection		3 x 0.14 mm ²	M8 x 1	3 x 0.14 mm ²	M8 x 1	3 x 0.14 mm ²

Please refer to Accessories for cable couplers, mounting brackets and sensor tester.



M18		M18		M18		
Flush	Flush	Non-flush	Non-flush	Non-flush	Non-flush	
5.0 mm	5.0 mm	8.0 mm	8.0 mm	8.0 mm	13.5 mm	
Cable 2 m	Connector M8	Cable 2 m	Cable 2 m	Connector M8	Connector M12	
					Sensing dist.	

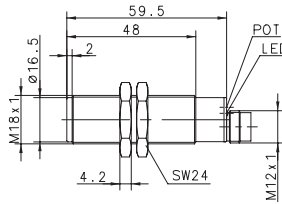
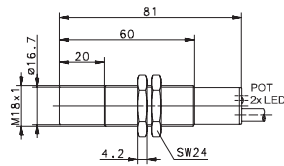
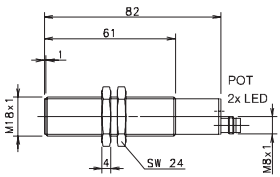
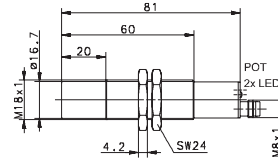
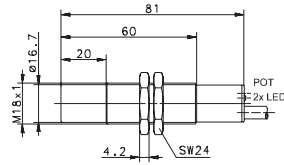
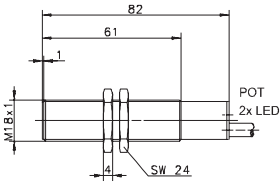

6507905001 KCB-M18PS/005-KLP2	6507905004 KCB-M18PS/005-KLPSM8	6507921724 KCN-T18PS/008-KLP2	6507921002 KCN-T18PS/008-KLPSM8	6507921004 KCN-T18PS/013-KLPS12V		
		6507821001 ^① KCN-T18PU/008-KLP2V				
6507305001 KCB-M18NS/005-KLP2		6507321723 KCN-T18NS/008-KLP2				
			6508521001 KCN-T18AS/008-LP2			
			6508421001 KCN-T18AÖ/008-LP2			

10–60 VDC	10–60 VDC	10–60 VDC	20–250 V AC	10–60 VDC	10–60 VDC	
200 mA	200 mA	200 mA	300 mA	200 mA	200 mA	
25 Hz	25 Hz	25 Hz	15 Hz	25 Hz	25 Hz	
Cyclic	Cyclic	Cyclic	–	Cyclic	Cyclic	
LED/LED	LED/LED	LED/LED	LED/LED	LED/LED	LED/LED	
Poti	Poti	Poti	Poti	Poti	Poti	

–25°C/+70°C	–25°C/+70°C	–25°C/+70°C	–25°C/+70°C	–25°C/+70°C	–25°C/+70°C	
IP65	IP65	IP65	IP65	IP65	IP65	
CuZn39Pb3	CuZn39Pb3	PBT, black	PBT, black	PBT, black	PBT, black	
3 x 0.5 mm ²	M8 x 1	3 x 0.5 mm ²	2 x 0.5 mm ²	M8 x 1	M12 x 1	

① Length 65 mm

